

USB-connect circuit

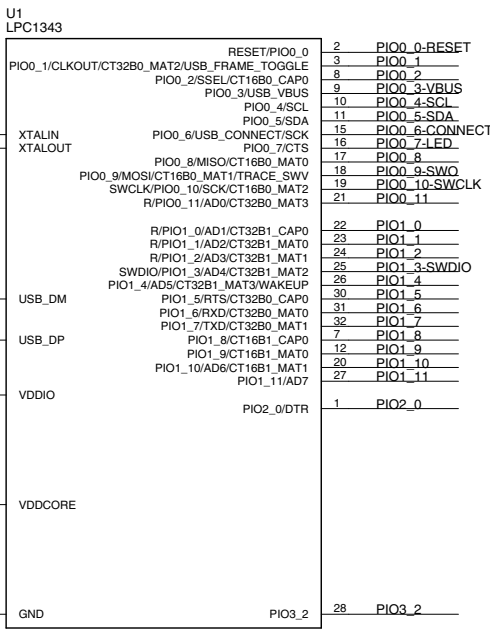

Expansion connectors

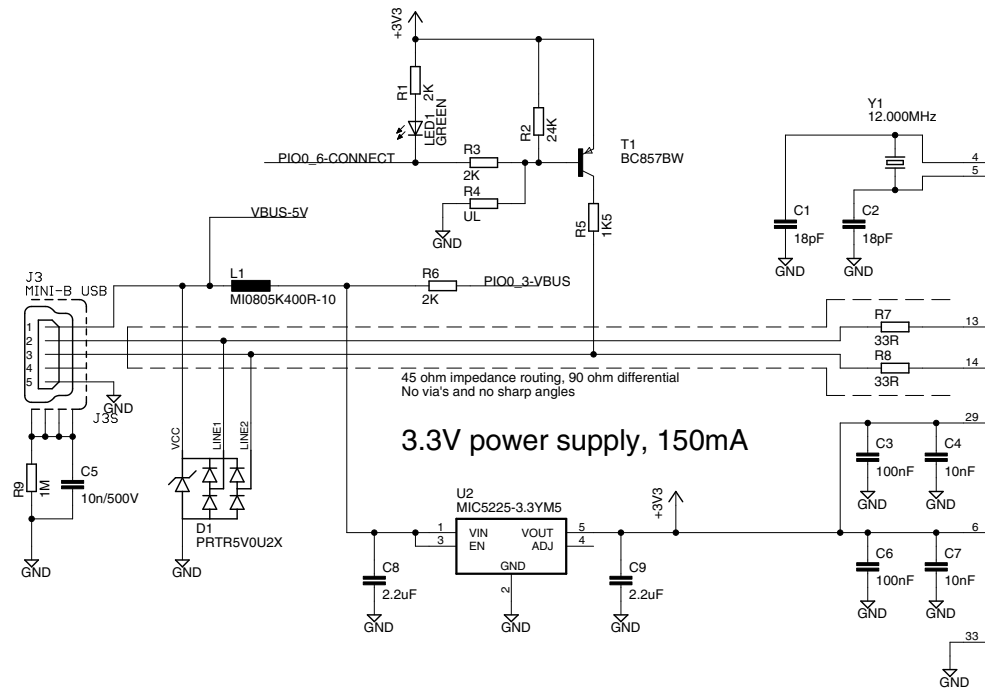
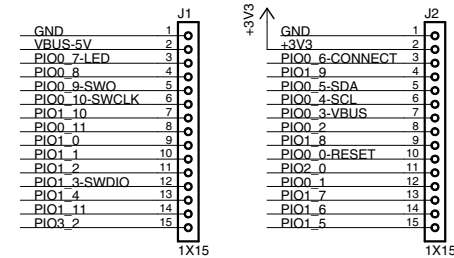

Bootload enable

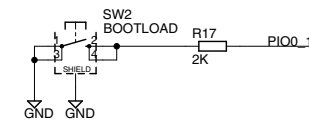

32Kbit I2C-E2PROM

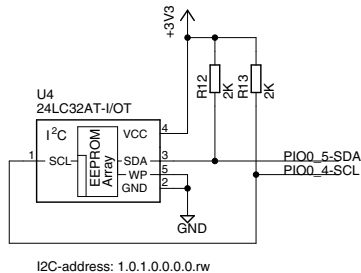

Reset generation

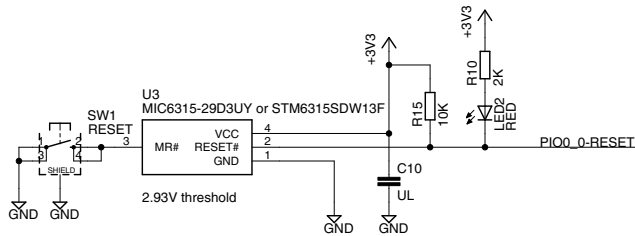

SWD interface

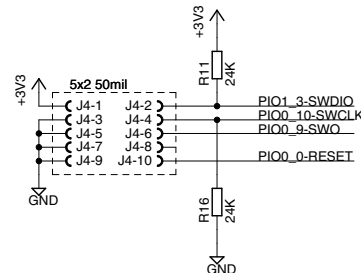

LED

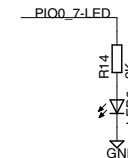

(C) Embedded Artists AB

TITLE: LPC1343 QSB rev A

Document Number:

Date: 2010-10-23 09:16:50

Sheet: 1/1