

USB-connect circuit

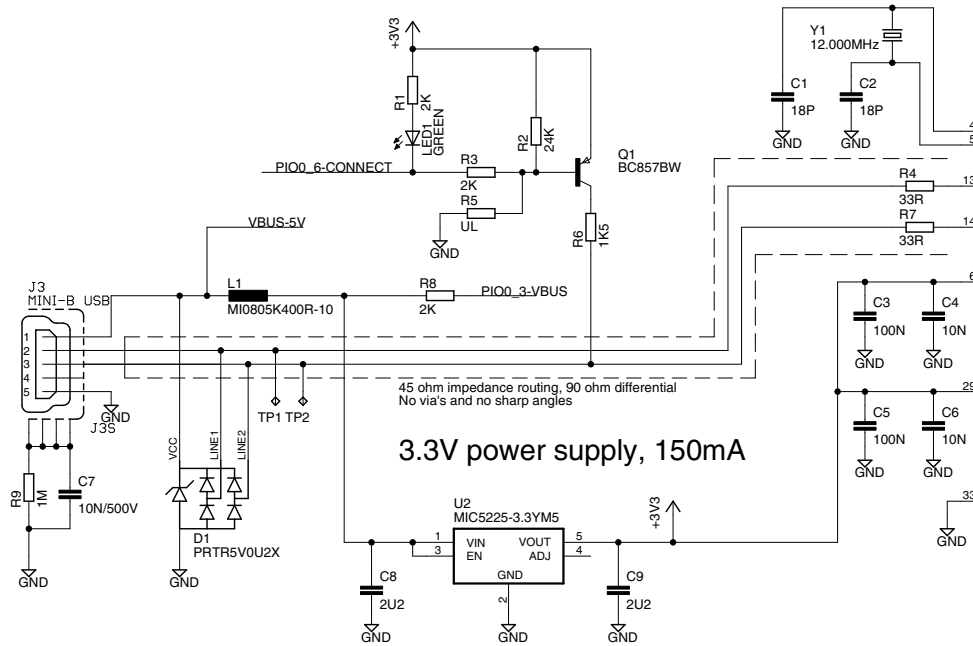

U1
LPC11U35FHN33/401

RESET/PIO0_0	2	PIO0_0-RESET
PIO0_1/CLKOUT/CT32B0_MAT2/USB_FRAME_TOGGLE	3	PIO0_1-ISP_EN
PIO0_2/SSEL0/CT16B0_CAP0	8	PIO0_2
PIO0_3/USB_VBUS	9	PIO0_3-VBUS
PIO0_4/SCL	10	PIO0_4-SCL
PIO0_5/SDA	11	PIO0_5-SDA
PIO0_6/USB_CONNECT/SCK0	15	PIO0_6-CONNECT
PIO0_7/CTS	16	PIO0_7-LED
PIO0_8/MISO0/CT16B0_MAT0	17	PIO0_8
PIO0_9/MOSI0/CT16B0_MAT1	18	PIO0_9
SWCLK/PIO0_10/SCK0/CT16B0_MAT2	19	PIO0_10-SWCLK
TDI/PIO0_11/AD0/CT32B0_MAT3	21	PIO0_11
TMS/PIO0_12/AD1/CT32B1_CAP0	22	PIO0_12
TDO/PIO0_13/AD2/CT32B1_MAT0	23	PIO0_13
TRST/PIO0_14/AD3/CT32B1_MAT1	24	PIO0_14
SWDIO/PIO0_15/AD4/CT32B1_MAT2	25	PIO0_15-SWDIO
PIO0_16/AD5/CT32B1_MAT3/WAKEUP	26	PIO0_16
PIO0_17/RXS/CT32B0_CAP0/SCLK	30	PIO0_17
PIO0_18/RXD/CT32B0_MAT0	31	PIO0_18
PIO0_19/TXD/CT32B0_MAT1	32	PIO0_19
PIO0_20/CT16B1_CAP0	7	PIO0_20
PIO0_21/CT16B1_MAT0/MOSI1	12	PIO0_21
PIO0_22/AD6/CT16B1_MAT1/MISO1	20	PIO0_22
PIO0_23/AD7	27	PIO0_23
PIO1_15/DCC/CT16B0_MAT2/SCK1	28	PIO1_15
PIO1_19/DTR/SSEL1	1	PIO1_19

Expansion connectors

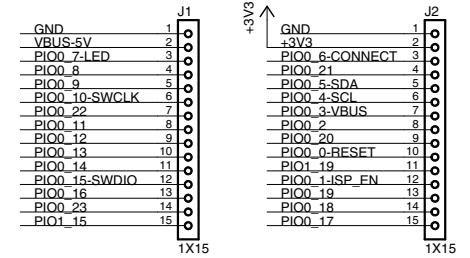

3.3V power supply, 150mA

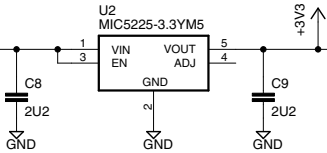

Bootload enable

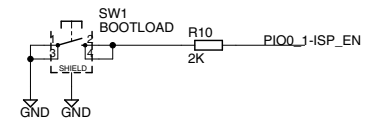

I2C-pullups

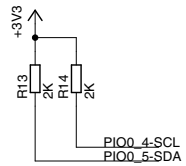

Reset generation

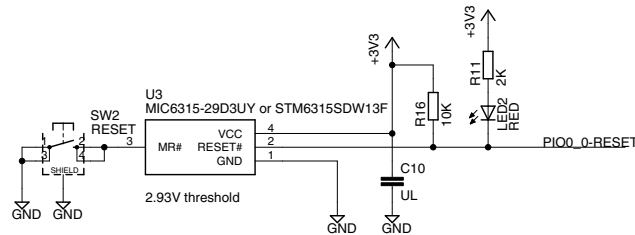

SWD interface

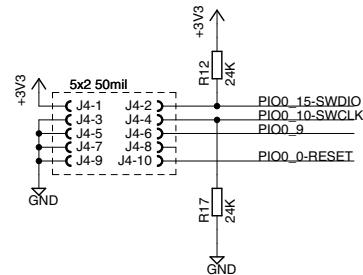

LED

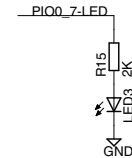

(C) Embedded Artists AB

TITLE: LPC11U35 QSB rev PA1

Document Number:

Date: 2012-03-09 22:56:56

Sheet: 1/1